

## Plastový tichý potrubný ventilátor XGF2E s AC motorom.

### POPIS:

Materiál: ABS plast

Motor: 2-stupňový motor s externým rotorom

Stupeň ochrany: IP44 (pre vnútornú inštaláciu)

Prevádzková teplota: -20 ° C ~ + 60 ° C



### TECHNICKÉ PARAMETRE:

Model	Reg. otáčok	Napájanie (V/Hz)	Prúd (A)	Príkon (w)	Najvyššia rýchlosť (ot./min.)	Vzd. Výkon (m3 / h)	Tlak (Pa)	Akust. tlak dB(A)
XGF2E-100	Vysoká	230/50	0,12	26	2200	200	155	31
	Nízka		0,11	23	1850	165	130	26
XGF2E-125	Vysoká	230/50	0,14	33	2250	285	160	31
	Nízka		0,13	28	1850	250	105	26
XGF2E-150	Vysoká	230/50	0,22	54	2550	530	300	33
	Nízka		0,19	44	1850	410	240	29
XGF2E-200	Vysoká	230/50	0,53	128	2450	840	350	63
	Nízka		0,52	123	1950	690	275	55
XGF2E-250	Vysoká	230/50	1,20	225	2450	1400	490	66
	Nízka		0,75	165	1850	1065	370	58
XGF2E-315	Vysoká	230/50	1,90	390	2350	2200	690	69
	Nízka		1,40	275	1650	1750	435	61

### ROZMERY:

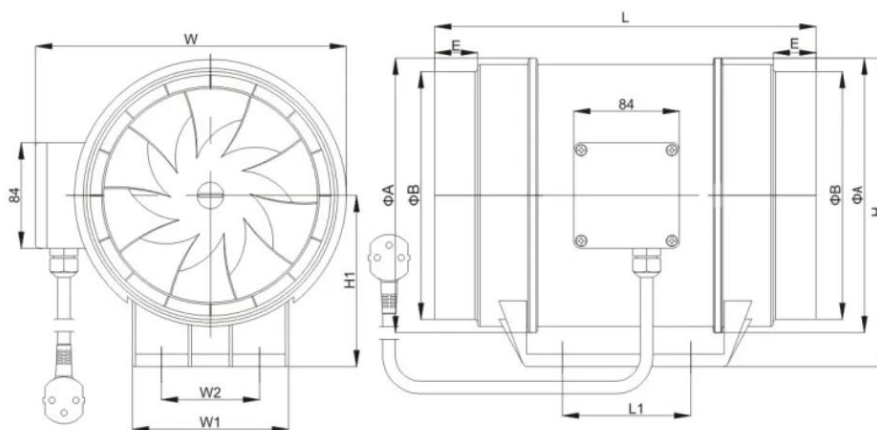

Model	A	B	E	H	H1	L	L1	W	W1	W2
XGF2E-100	138	96	28	149	80	230	73	166	88	55
XGF2E-125	174	123	30	187	100	258	80	203	97	60
XGF2E-150	199	146	44	211	111	313	77	227	119	74
XGF2E-200	218	197	34	245	136	303	102	247	124	78
XGF2E-250	251	245	34	275	145	385	133	300	124	100
XGF2E-315	320	310	34	340	175	445	185	360	144	112

## CHARAKTERISTIKY:

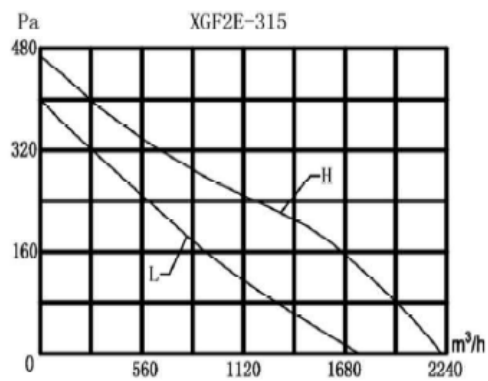
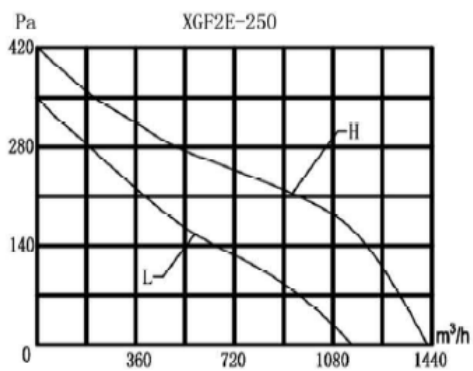
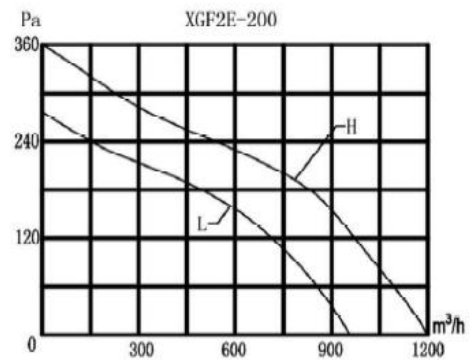
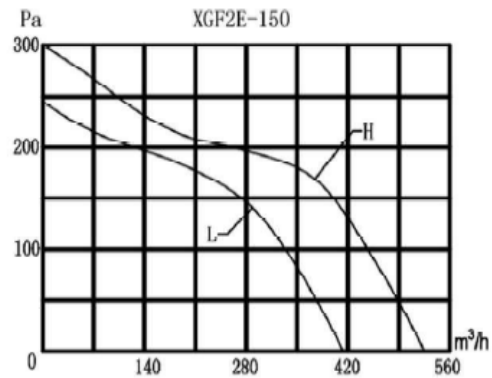
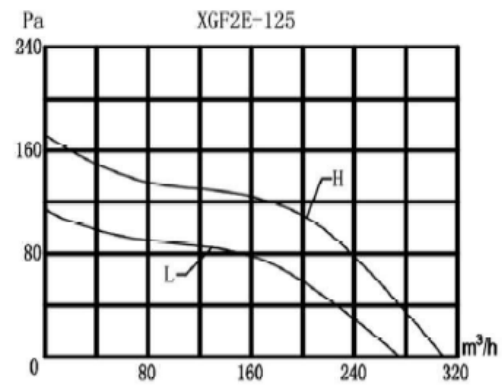
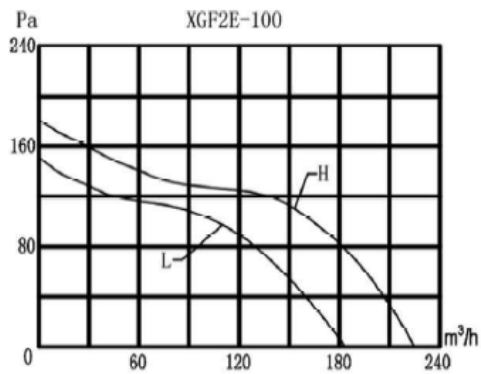

## SCHÉMA ZAPOJENIA:

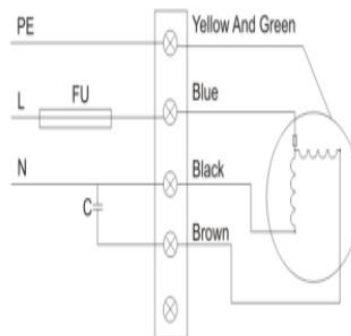

## POUŽITIE:

### Domácnosť

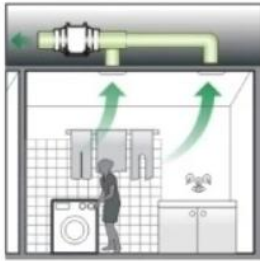

Práčovňa

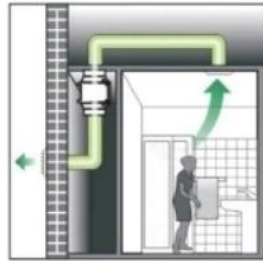

Kúpeľňa

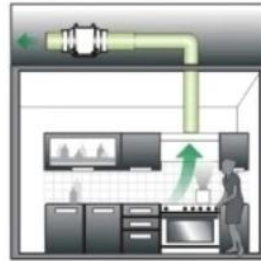

Kuchyňa



Toalety

### Projekt a inštalácia

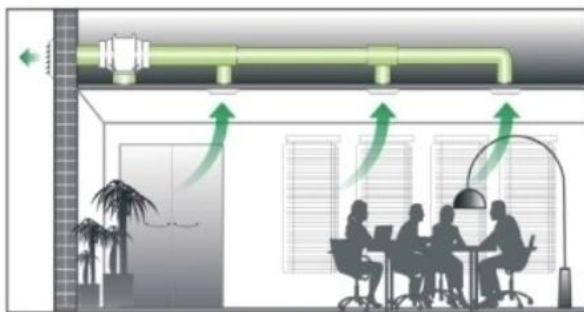

Zasadacia miestnosť

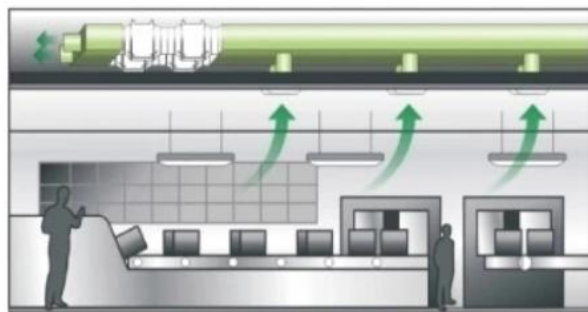

Továreň

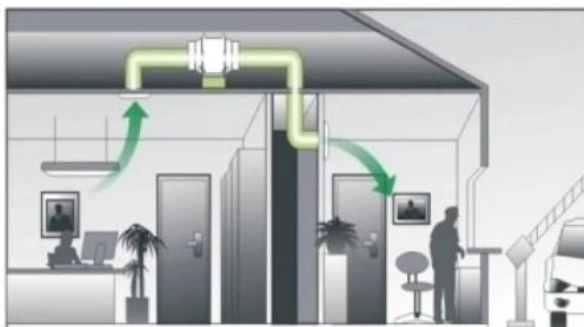

Administratívne priestory

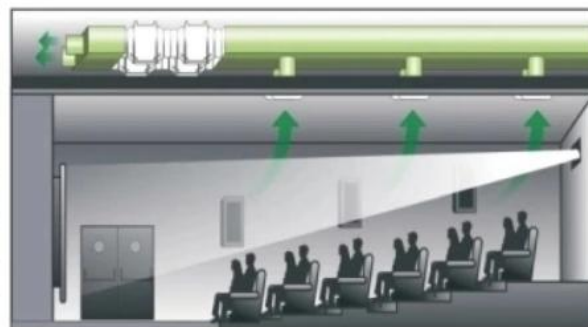

Kino